

LB-75-25-C-SF Standard Gain Horn Antenna 10-15GHz 25dB Gain SMA Female



Standard Gain Horn Antenna Operating From 10GHz to 15GHz With a Nominal 25dB Gain With SMA Female Connector

Product Information

SKU	LB-75-25-C-SF
-----	---------------

Description

Standard Gain Horn Antenna LB-75-25-C-SF, operating from 10 to 15GHz with a nominal 25dB gain and low VSWR 1.25:1 with SMA Female connector output. The model LB-75-25-C-SF has uniform gain through its frequency span, providing efficient performance characteristics and directionality. It can handle 50W continuously and 3000W peak power. Constructed of lightweight corrosion-resistant aluminum, the antenna will provide years of trouble-free indoor and outdoor service. This standard gain horn antenna is linearly polarized and ideally suited for EMI testing, direction finding, surveillance, antenna gain and pattern measurements and other applications.

Technical Specification

Electrical Specification		Interface	
Frequency, Min (GHz)	10	Output Type	Coaxial
Frequency, Max (GHz)	15	Connector	SMA
Waveguide Type	Rectangular	Connector Gender	Female
Waveguide Size EIA WR	WR75	Mechanical Specification	
Gain, Typ (dBi)	25	Figure	C Type
Polarization	Linear	Body Material	Al
3dB Beamwidth, E-Plane, Typ (Deg.)	9	Finish	Chemical Conversion Coating, Gray Paint
3dB Beamwidth, H-Plane, Typ (Deg.)	10	Size, W (mm)	185
Cross Pol. Isolation, Typ (dB)	35	Size, H (mm)	155
VSWR, Typ	1.25:1	Size, L (mm)	430
Impedance, (Ohm)	50	Weight, (kg)	0.65
Power Handling, CW, (W)	50		
Power Handling, Peak, (W)	3000		

Additional Information

Application	General Purpose Indoor & Outdoor, Fixed	Solution for	Gain Reference Antenna Measurement Reflector Feed Far-field Measurement System Intergration Material Measurement
-------------	---	--------------	---

Outline Drawing

SMA-Female Output (P/N: LB-75-25-C-SF)

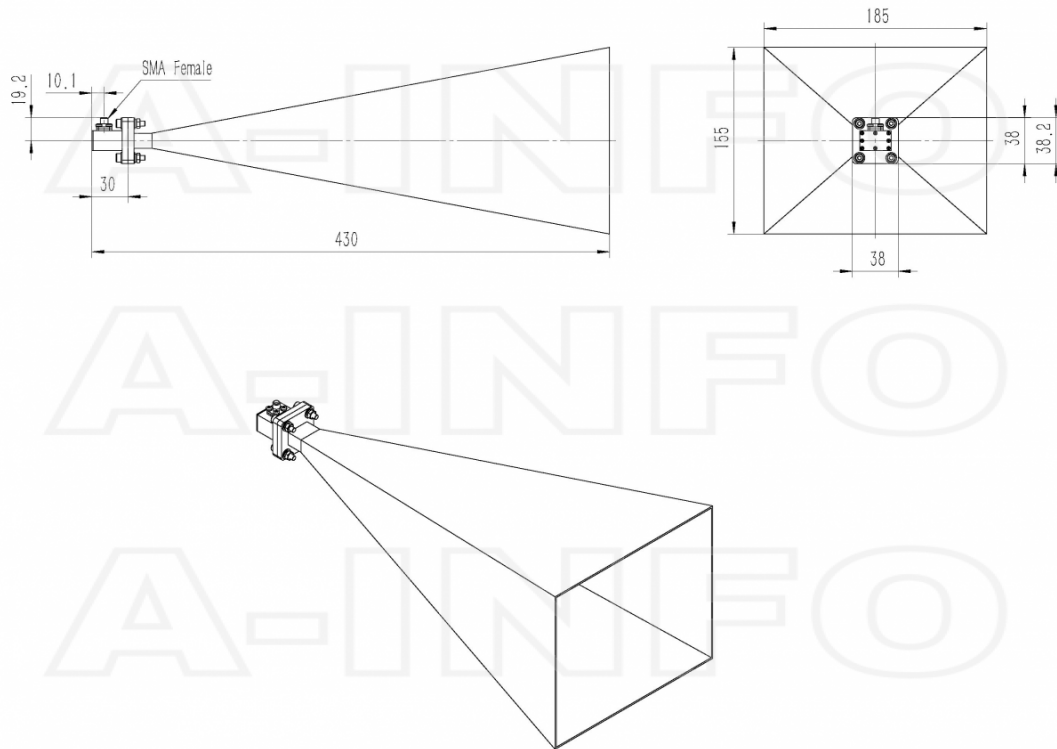

SMA-Female Output with Round Mounting Bracket (Option, P/N: LB-75-10-C-MB)

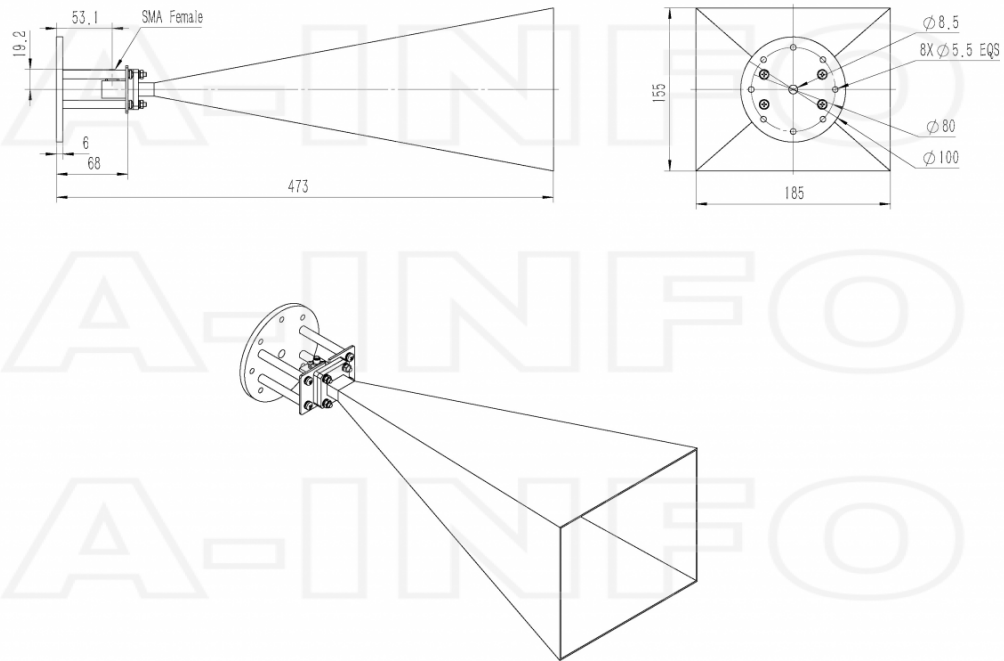

SMA-Female Output with L Type Mounting Bracket (Option, P/N: LB-75-10-C-MBL)

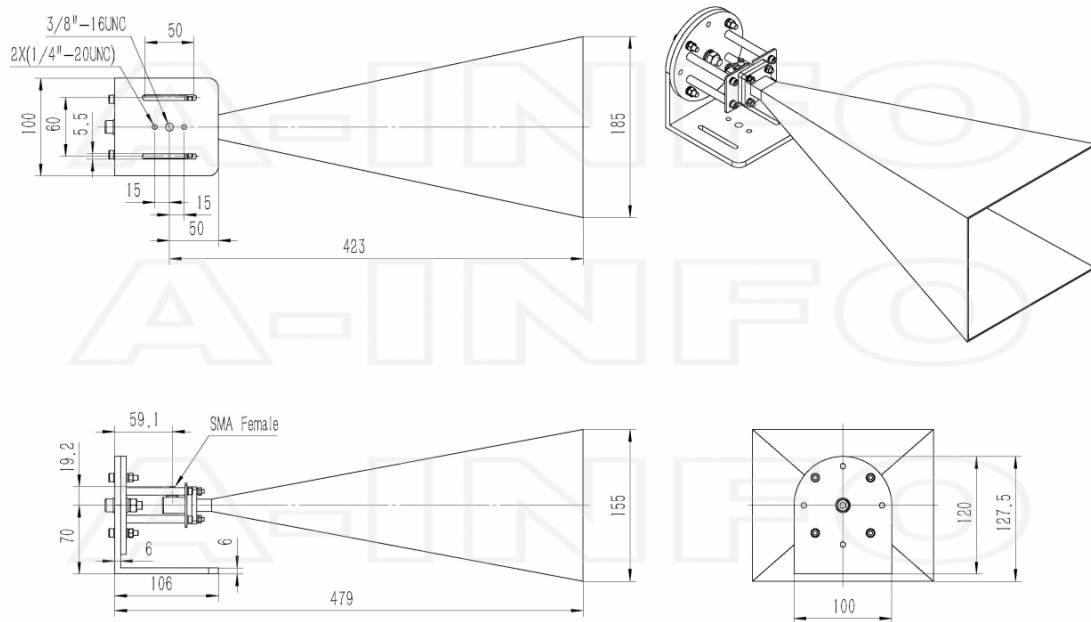

Typical Test Results

Gain

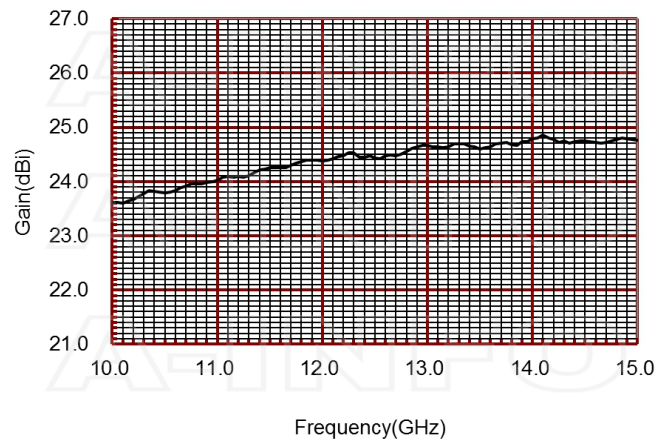

Antenna Factor

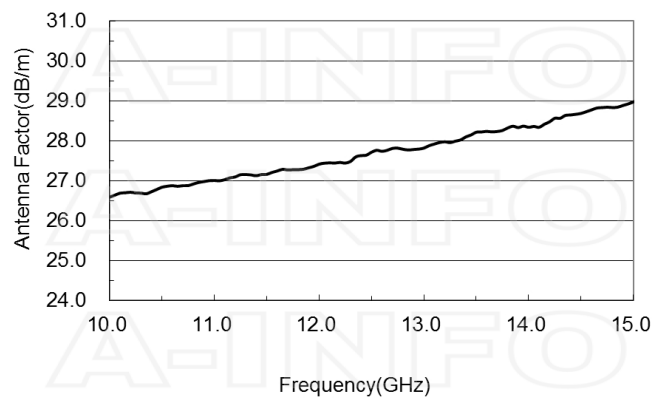

Antenna Factor (Table)

Frequency(GHz)	Gain(dBi)	Antenna Factor(dB/m)
10.00	23.62	26.59
10.50	23.79	26.84
11.00	24.03	27.01
11.50	24.26	27.16
12.00	24.38	27.42
12.50	24.43	27.71
13.00	24.67	27.82
13.50	24.60	28.22
14.00	24.79	28.34
14.50	24.75	28.69
15.00	24.76	28.97

Cross Polarization Isolation

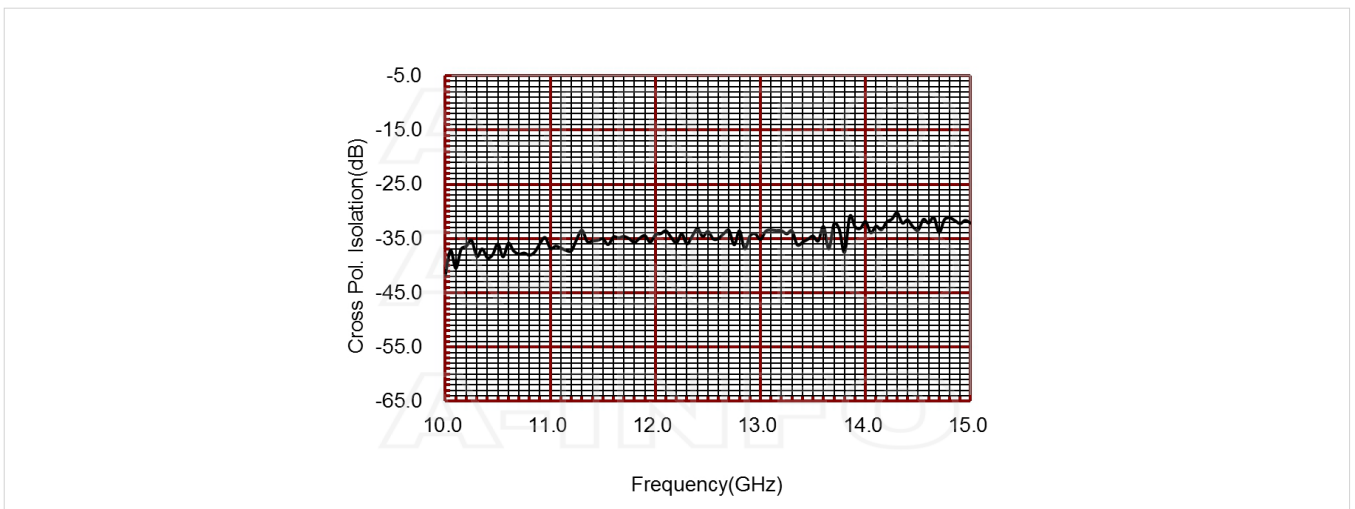

VSWR

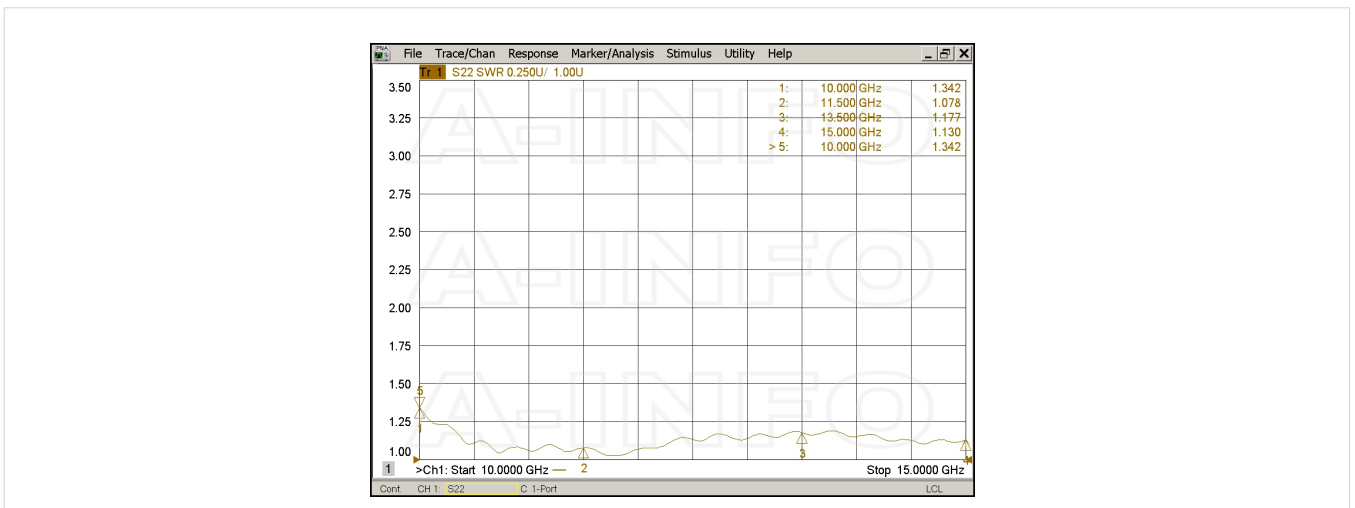

Pattern

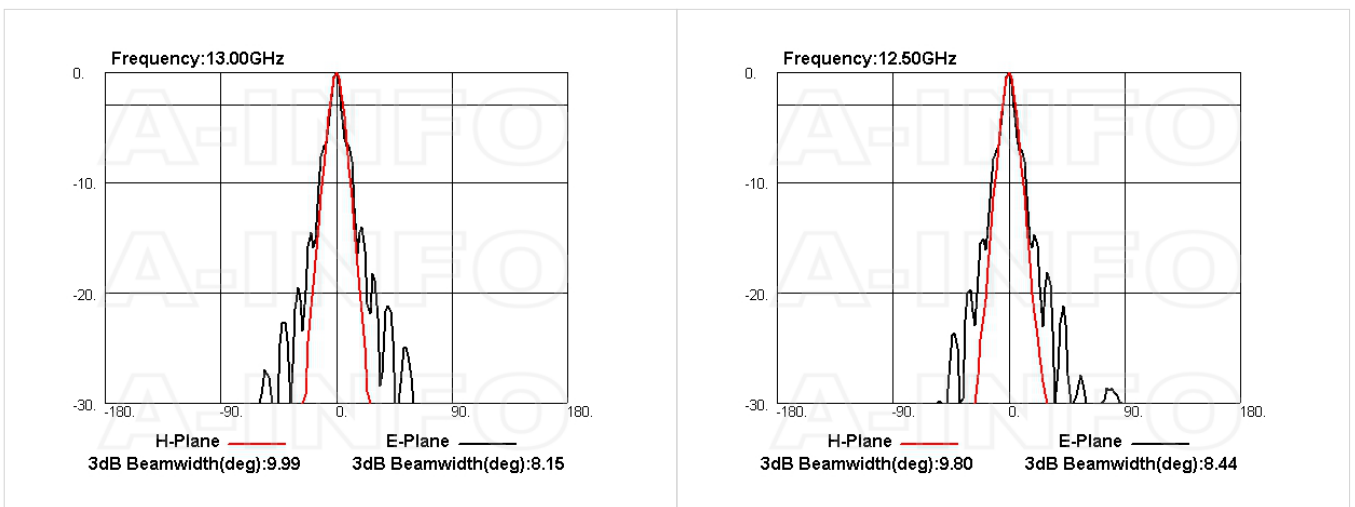

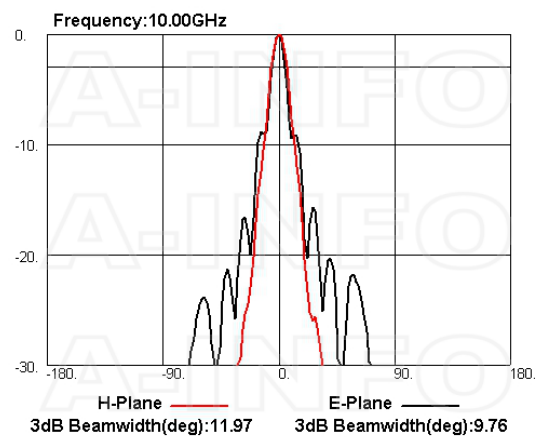
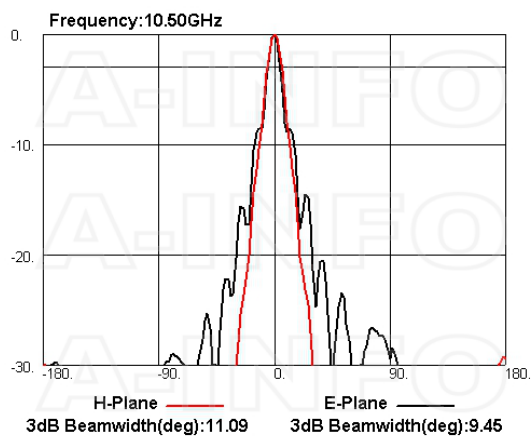
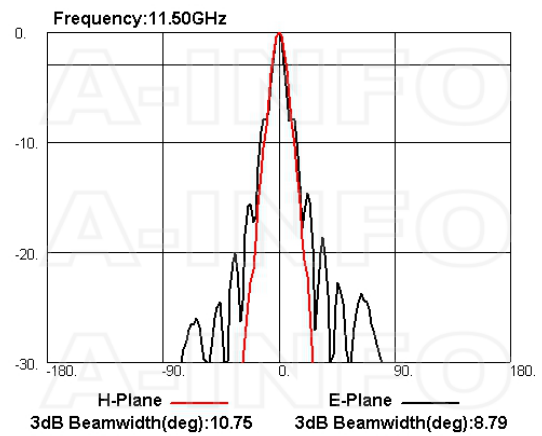
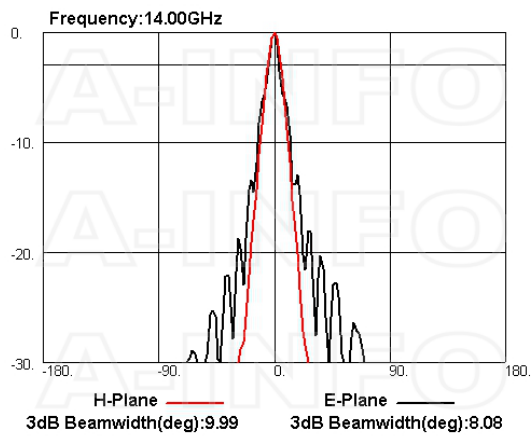
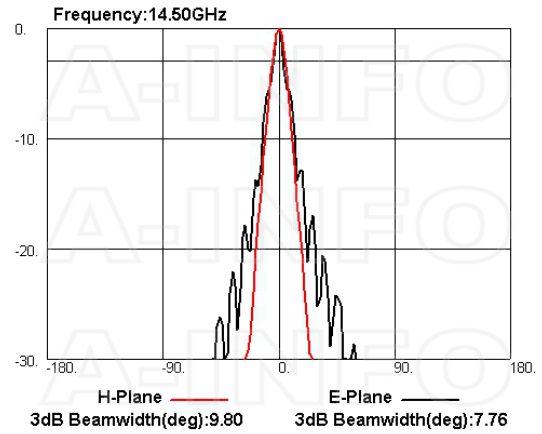
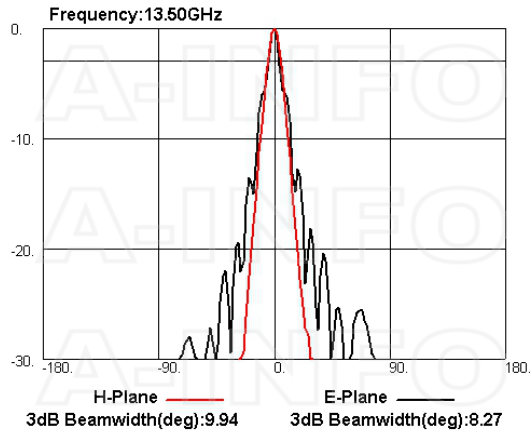

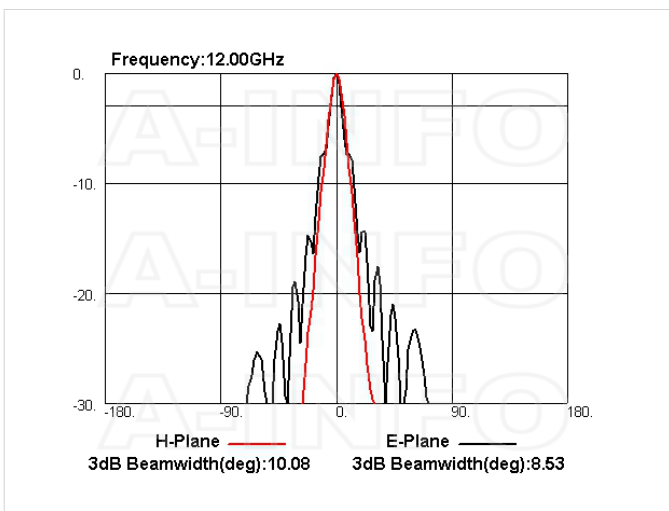
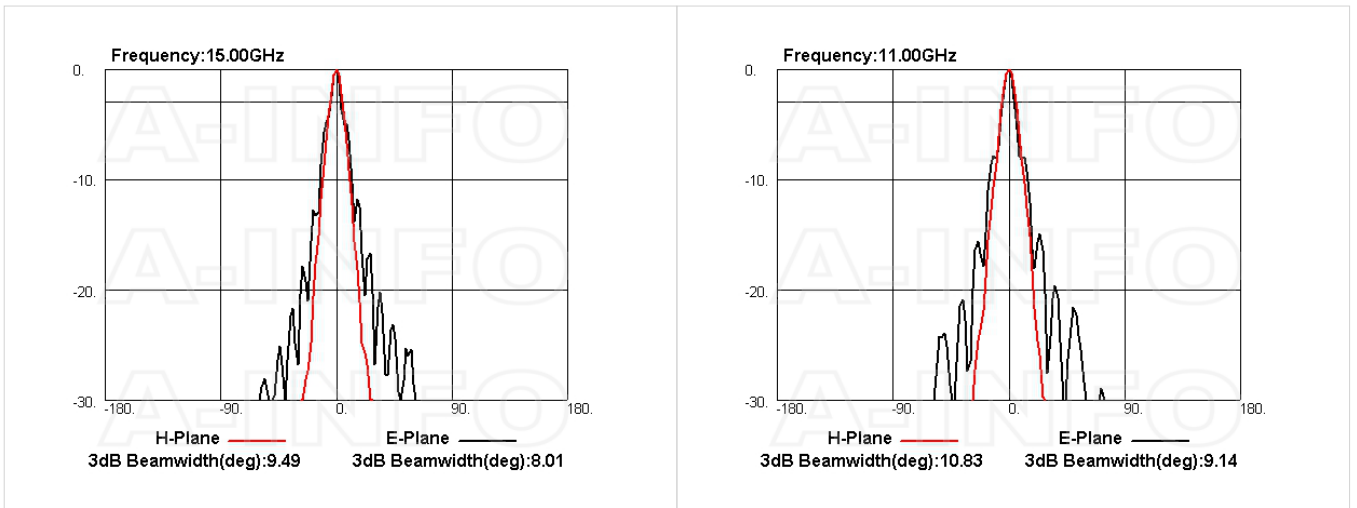

Related Products



LB-75-10-C-MB Round Type Mounting Bracket



LB-75-10-C-MBL L type mounting bracket



Tripod_15Kg Al Alloy Tripod



3033HL Wooden Tripod



3033QM Wooden Tripod Metalfree



M4x12 Hex_Pack WR51-WR112 Assembly Pack



M4x20 Hex_Pack WR112- WR51 Flange Assembly Pack



M4x30 Hex_Pack Log Periodic, DS Assembly Pack



SM-SM-A050-1000 Flexible Cable Assembly 1000mm DC- 26.5GHz SMA Male to SMA Male



SM-SM-A050-1500 Flexible Cable Assembly 1500mm DC- 26.5GHz SMA Male to SMA Male



SM-SM-A050-2000 Flexible Cable Assembly 2000mm DC- 26.5GHz SMA Male to SMA Male



SM-SM-A050-3000 Flexible Cable Assembly 3000mm DC- 26.5GHz SMA Male to SMA Male



SM-SM-A050-5000 Flexible Cable Assembly 5000mm DC- 26.5GHz SMA Male to SMA Male



SM-SM-A050-10000 Flexible Cable Assembly 10000mm DC- 26.5GHz SMA Male to SMA Male



SM-SM-A080-1000 Flexible Cable Assembly 1000mm DC- 26.5GHz SMA Male to SMA Male



SM-SM-A080-1500 Flexible Cable Assembly 1500mm DC- 26.5GHz SMA Male to SMA Male



SM-SM-A080-2000 Flexible Cable Assembly 2000mm DC- 26.5GHz SMA Male to SMA Male



SM-SM-A080-3000 Flexible Cable Assembly 3000mm DC- 26.5GHz SMA Male to SMA Male



SM-SM-A080-5000 Flexible Cable Assembly 5000mm DC- 26.5GHz SMA Male to SMA Male



SM-SM-A080-10000 Flexible Cable Assembly 10000mm DC- 26.5GHz SMA Male to SMA Male



SM-SM-A080-20000 Flexible Cable Assembly 20000mm DC-26.5GHz SMA Male to SMA Male

Similar Products



LB-75-25-A Standard Gain Horn Antenna 10-15GHz 25dB Gain Rectangular Waveguide Interface



LB-75-25-ASPO Standard Gain Horn Antenna 10-15GHz 25dB Gain Rectangular Waveguide Interface

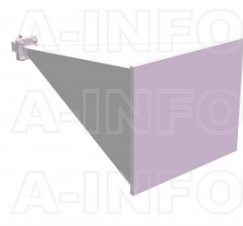

LB-75-25-C-SFSP0 Standard Gain Horn Antenna 10-15GHz 25dB Gain SMA Female



LB-75-25-C-NF Standard Gain Horn Antenna 10-15GHz 25dB Gain N Type Female

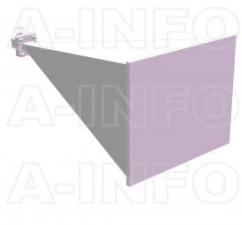

LB-75-25-C-NFSP0 Standard Gain Horn Antenna 10-15GHz 25dB Gain N Type Female



LB-75-25-C-TF Standard Gain Horn Antenna 10-15GHz 25dB Gain TNC Female

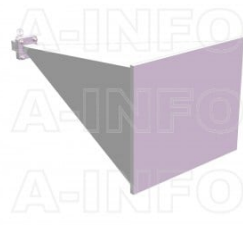

LB-75-25-C-TFSP0 Standard Gain Horn Antenna 10-15GHz 25dB Gain TNC Female

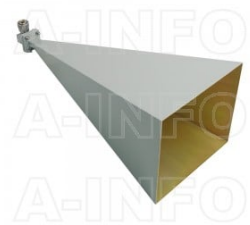

LB-75-25-C-7 Standard Gain Horn Antenna 10-15GHz 25dB Gain 7mm

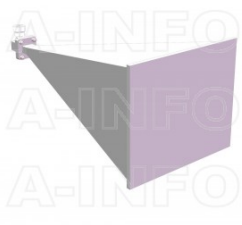

LB-75-25-C-7SPO Standard Gain Horn Antenna 10-15GHz 25dB Gain 7mm



LB-75-25-C-3.5F Standard Gain Horn Antenna 10-15GHz 25dB Gain 3.5mm Female

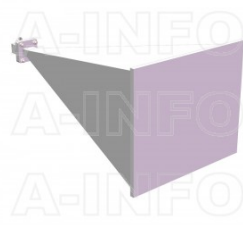

LB-75-25-C-3.5FSP0 Standard Gain Horn Antenna 10-15GHz 25dB Gain 3.5mm Female

About this Datasheet

<ul style="list-style-type: none">● Product Information <p>Product Link: https://www.ainfoinc.com/lb-75-25-c-sf-standard-gain-horn-antenna-10-15-ghz-25db-gain-sma-female Data subject to change without notice. © A-INFO INC. 2023. All Rights Reserved</p>	<ul style="list-style-type: none">● Contact Us <p>Address:dd 60 Tesla, Irvine, CA 92618, USA</p> <p>Website: www.ainfoinc.com</p> <p>Email: sales@ainfoinc.com</p>	<ul style="list-style-type: none">● Phone & Fax <p>Phone: +1-949-639-9688 +1-949-639-9608</p> <p>Fax: +1-949-639-9670</p>
--	---	--